



ÖFA®

OTO AYNA & YEDEK PARÇA
AUTO MIRROR & SPARE PARTS

2016-2017
Catalogue

FELSEFE

Misyonumuz kaliteli ve sađlam ürünlerle müşterilerimizin araçlarında güvenli bir şekilde seyahat etmelerini sađlamak ve ürünlerimize yönelik memnuniyetlerini en üst seviyede tutmaktır.

Vizyonumuz 40 yıllık tecrübemize çağın gerekliliklerini ve teknolojik gelişmeleri entegre ederek insan sađlığına ve çevreye duyarlı ürünler ile sürekliliđi sađlamak.

Hedefimiz otomotiv sektöründe ürettiđimiz ürünlerde tercih edilen bir marka olarak ebedi müessese ve dünya şirketi olmak.

Ömer Faruk ATAMAK

PHYLOSOPHY

PHYLOSOPHY

Our missions are to ensure our customers safe journey in their vehicles and to keep their highest level of satisfaction with quality and durable products.

Our vision is to provide the continuity of products which are sensitive to human health and the environment through integrating the requirements of the necessities of the modern world and technological developments into our 40 years experience.

Our goal is to become an eternal corporation and world company as a brand preferred for its products in automotive industry.

Ömer Faruk ATAMAK



Product ID: 150.100.146 – 150.100.147

Product Name: Visio

Features	Avlb.	Unavlb.	Info
Heater	<input checked="" type="checkbox"/>		(24v.)
Manual Adjustable	[A]		
Electric Adjustable	[B]		(24v.)
Mirror: Class II	<input checked="" type="checkbox"/>		[B]
Mirror: Class IV	<input checked="" type="checkbox"/>		[A]
Right	<input checked="" type="checkbox"/>		150.100.146
Left	<input checked="" type="checkbox"/>		150.100.147
Side Indicator Lamp	<input checked="" type="checkbox"/>		(yellow led)
Position Lamp	<input checked="" type="checkbox"/>		(white led)
Left-hand Drive	<input checked="" type="checkbox"/>		
Right-hand Drive	<input checked="" type="checkbox"/>		
E-Mark	<input checked="" type="checkbox"/>		II-E9-02.6656 IV-E9-02.6655
Aspherical Mirror	<input checked="" type="checkbox"/>		(optional)
Colour	<input checked="" type="checkbox"/>		(optional)



Camera Technical Specifications

- 1/4" CMOS Sensor
- 1.5 Lux, 170° Wide Angle Lens
- 420TVL Resolutions
- S/N Ratio: 46dB
- 1.0VP-P 75ohm video out put
- IP68 Water-proof
- Normal or mirror view (opt.)
- 420 TVL
- AGC (Automatic), BLC (Automatic)
- Easy setup and assembly
- 4 Pin thin cable
- Water proof cable design
- Vibration free connection structure
- -30°C ~ 70°C Operating Temperature Range

Screen Technical Specifications

- 7" Digital TFT LCD Color Screen (Quad)
- 800 x 480 Pıksel Resolution (PAL/NTSC)
- Turkish OSD
- 4 Channel Video Out Put
- 60° Watching Angle
- 350 cd/m2 Brightness
- 300 / 1 Contrast
- Mirror View
- View Change
- Screen Strut
- Remote Control (Full Control)



Product ID: 150.100.081 – 150.100.082

Product Name: Ultima

Features	Avlb.	Unavlb.	Info
Heater	<input checked="" type="checkbox"/>		(24v.)
Manual Adjustable	<input checked="" type="checkbox"/>		
Electric Adjustable	<input checked="" type="checkbox"/>		(24v.)
Mirror: Class II	<input checked="" type="checkbox"/>		[B]
Mirror: Class IV	<input checked="" type="checkbox"/>		[A]
Right	<input checked="" type="checkbox"/>		150.100.081
Left	<input checked="" type="checkbox"/>		150.100.082
Side Indicator Lamp	<input checked="" type="checkbox"/>		(yellow led)
Position Lamp	<input checked="" type="checkbox"/>		(white led)
Left-hand Drive	<input checked="" type="checkbox"/>		
Right-hand Drive		<input checked="" type="checkbox"/>	
E-Mark	<input checked="" type="checkbox"/>		II-E9-02.6656 IV-E9-02.6655
Aspherical Mirror		<input checked="" type="checkbox"/>	
Colour	<input checked="" type="checkbox"/>		(optional)



Product ID: 150.100.156 – 150.100.157

Product Name: Ultima

Features	Avlb.	Unavlb.	Info
Heater	<input checked="" type="checkbox"/>		(24v.)
Manual Adjustable	<input checked="" type="checkbox"/>		
Electric Adjustable	<input checked="" type="checkbox"/>		(24v.)
Mirror: Class II	<input checked="" type="checkbox"/>		[B]
Mirror: Class IV	<input checked="" type="checkbox"/>		[A]
Right	<input checked="" type="checkbox"/>		150.100.156
Left	<input checked="" type="checkbox"/>		150.100.157
Side Indicator Lamp	<input checked="" type="checkbox"/>		(yellow led)
Position Lamp	<input checked="" type="checkbox"/>		(white led)
Left-hand Drive	<input checked="" type="checkbox"/>		
Right-hand Drive		<input checked="" type="checkbox"/>	
E-Mark	<input checked="" type="checkbox"/>		II-E9-02.6656 IV-E9-02.6655
Aspherical Mirror		<input checked="" type="checkbox"/>	
Colour	<input checked="" type="checkbox"/>		(optional)



Product ID: 150.100.083 – 150.100.084

Product Name: Futura

Features	Avlb.	Unavlb.	Info
Heater	<input checked="" type="checkbox"/>		(24v.)
Manual Adjustable		<input checked="" type="checkbox"/>	
Electric Adjustable	<input checked="" type="checkbox"/>		(24v.)
Mirror: Class II	<input checked="" type="checkbox"/>		
Mirror: Class IV		<input checked="" type="checkbox"/>	
Right	<input checked="" type="checkbox"/>		150.100.083
Left	<input checked="" type="checkbox"/>		150.100.084
Side Indicator Lamp	<input checked="" type="checkbox"/>		(yellow led)
Position Lamp	<input checked="" type="checkbox"/>		(white led)
Left-hand Drive	<input checked="" type="checkbox"/>		
Right-hand Drive		<input checked="" type="checkbox"/>	
E-Mark	<input checked="" type="checkbox"/>		II-E9-02.6657
Aspherical Mirror	<input checked="" type="checkbox"/>		
Colour	<input checked="" type="checkbox"/>		(optional)



Product ID: 150.100.086 – 150.100.087

Product Name: Azra

Features	Avlb.	Unavlb.	Info
Heater	<input checked="" type="checkbox"/>		(24v.)
Manual Adjustable	<input checked="" type="checkbox"/>		
Electric Adjustable	<input checked="" type="checkbox"/>		(24v.)
Mirror: Class II	<input checked="" type="checkbox"/>		[B]
Mirror: Class IV	<input checked="" type="checkbox"/>		[A]
Right	<input checked="" type="checkbox"/>		150.100.086
Left	<input checked="" type="checkbox"/>		150.100.087
Side Indicator Lamp	<input checked="" type="checkbox"/>		(yellow led)
Position Lamp	<input checked="" type="checkbox"/>		(white led)
Left-hand Drive	<input checked="" type="checkbox"/>		
Right-hand Drive	<input checked="" type="checkbox"/>		
E-Mark	<input checked="" type="checkbox"/>		II-E9-02.6656 IV-E9-02.6655
Aspherical Mirror		<input checked="" type="checkbox"/>	
Colour	<input checked="" type="checkbox"/>		(optional)



Product ID: 150.100.088 – 150.100.090

Product Name: Ametis

Features	Avlb.	Unavlb.	Info
Heater	<input checked="" type="checkbox"/>		(24v.)
Manual Adjustable		<input checked="" type="checkbox"/>	
Electric Adjustable	<input checked="" type="checkbox"/>		(24v.)
Mirror: Class II	<input checked="" type="checkbox"/>		
Mirror: Class IV		<input checked="" type="checkbox"/>	
Right	<input checked="" type="checkbox"/>		150.100.088
Left	<input checked="" type="checkbox"/>		150.100.090
Side Indicator Lamp	<input checked="" type="checkbox"/>		(yellow led)
Position Lamp	<input checked="" type="checkbox"/>		(white led)
Left-hand Drive	<input checked="" type="checkbox"/>		
Right-hand Drive	<input checked="" type="checkbox"/>		
E-Mark	<input checked="" type="checkbox"/>		II-E9-02.6657
Aspherical Mirror	<input checked="" type="checkbox"/>		(optional)
Colour	<input checked="" type="checkbox"/>		(optional)



Product ID: 150.100.021 – 150.100.029 - 150.100.030

Product Name: Merc. O403/Man S2000 type

Features	Avlb.	Unavlb.	Info
Heater	<input checked="" type="checkbox"/>		(24v.)
Manual Adjustable		<input checked="" type="checkbox"/>	
Electric Adjustable	<input checked="" type="checkbox"/>		(24v.)
Mirror: Class II	<input checked="" type="checkbox"/>		
Mirror: Class IV		<input checked="" type="checkbox"/>	
Right	<input checked="" type="checkbox"/>		
Left	<input checked="" type="checkbox"/>		
Side Indicator Lamp		<input checked="" type="checkbox"/>	
Position Lamp		<input checked="" type="checkbox"/>	
Left-hand Drive	<input checked="" type="checkbox"/>		
Right-hand Drive		<input checked="" type="checkbox"/>	
E-Mark	<input checked="" type="checkbox"/>		II-E9-03.6921
Aspherical Mirror	<input checked="" type="checkbox"/>		(optional)
Colour	<input checked="" type="checkbox"/>		(optional)



Product ID: 150.100.019 – 150.100.025 – 150.100.026

Product Name: Merc. O403/Man S2000 type

Features	Avlb.	Unavlb.	Info
Heater	<input checked="" type="checkbox"/>		(24v.)
Manual Adjustable	<input checked="" type="checkbox"/>		
Electric Adjustable		<input checked="" type="checkbox"/>	
Mirror: Class II	<input checked="" type="checkbox"/>		
Mirror: Class IV		<input checked="" type="checkbox"/>	
Right	<input checked="" type="checkbox"/>		
Left	<input checked="" type="checkbox"/>		
Side Indicator Lamp		<input checked="" type="checkbox"/>	
Position Lamp		<input checked="" type="checkbox"/>	
Left-hand Drive	<input checked="" type="checkbox"/>		
Right-hand Drive		<input checked="" type="checkbox"/>	
E-Mark	<input checked="" type="checkbox"/>		II-E9-03.6921
Aspherical Mirror	<input checked="" type="checkbox"/>		(optional)
Colour	<input checked="" type="checkbox"/>		(optional)

Product ID: 150.100.024 – 150.100.140

Product Name: Provera

Features	Avlb.	Unavlb.	Info
Heater	<input checked="" type="checkbox"/>		(24v.)
Manual Adjustable	<input checked="" type="checkbox"/>		
Electric Adjustable	<input checked="" type="checkbox"/>		(24v.)
Mirror: Class II	<input checked="" type="checkbox"/>		[B]
Mirror: Class IV	<input checked="" type="checkbox"/>		[A]
Right	<input checked="" type="checkbox"/>		150.100.086
Left	<input checked="" type="checkbox"/>		150.100.087
Side Indicator Lamp	<input checked="" type="checkbox"/>		(yellow led)
Position Lamp	<input checked="" type="checkbox"/>		(white led)
Left-hand Drive	<input checked="" type="checkbox"/>		
Right-hand Drive	<input checked="" type="checkbox"/>		
E-Mark	<input checked="" type="checkbox"/>		II-E9-02.6656 IV-E9-02.6655
Aspherical Mirror		<input checked="" type="checkbox"/>	
Colour	<input checked="" type="checkbox"/>		(optional)



Product ID: 150.100.023 – 150.100.138

Product Name: Provera

Features	Avlb.	Unavlb.	Info
Heater	<input checked="" type="checkbox"/>		(24v.)
Manual Adjustable	<input checked="" type="checkbox"/>		
Electric Adjustable		<input checked="" type="checkbox"/>	
Mirror: Class II	<input checked="" type="checkbox"/>		[B]
Mirror: Class IV	<input checked="" type="checkbox"/>		[A]
Right	<input checked="" type="checkbox"/>		150.100.086
Left	<input checked="" type="checkbox"/>		150.100.087
Side Indicator Lamp	<input checked="" type="checkbox"/>		(yellow led)
Position Lamp	<input checked="" type="checkbox"/>		(white led)
Left-hand Drive	<input checked="" type="checkbox"/>		
Right-hand Drive	<input checked="" type="checkbox"/>		
E-Mark	<input checked="" type="checkbox"/>		II-E9-02.6656 IV-E9-02.6655
Aspherical Mirror	<input checked="" type="checkbox"/>		
Colour	<input checked="" type="checkbox"/>		(optional)



Product ID: 150.100.061 – 150.100.062

Product Name: Diamond

Features	Avlb.	Unavlb.	Info
Heater	<input checked="" type="checkbox"/>		(24v.)
Manual Adjustable	<input checked="" type="checkbox"/>		
Electric Adjustable	<input checked="" type="checkbox"/>		(24v.)
Mirror: Class II	<input checked="" type="checkbox"/>		[B]
Mirror: Class IV	<input checked="" type="checkbox"/>		[A]
Right	<input checked="" type="checkbox"/>		150.100.062
Left	<input checked="" type="checkbox"/>		150.100.061
Side Indicator Lamp	<input checked="" type="checkbox"/>		(yellow led)
Position Lamp	<input checked="" type="checkbox"/>		(white led)
Left-hand Drive	<input checked="" type="checkbox"/>		
Right-hand Drive	<input checked="" type="checkbox"/>		
E-Mark	<input checked="" type="checkbox"/>		II-E9-02.6656 IV-E9-02.6655
Aspherical Mirror		<input checked="" type="checkbox"/>	
Colour	<input checked="" type="checkbox"/>		(optional)



Product ID: 150.100.075 – 150.100.076

Product Name: Univera

Features	Avlb.	Unavlb.	Info
Heater	<input checked="" type="checkbox"/>		(24v.)
Manual Adjustable		<input checked="" type="checkbox"/>	
Electric Adjustable	<input checked="" type="checkbox"/>		(24v.)
Mirror: Class II	<input checked="" type="checkbox"/>		
Mirror: Class IV		<input checked="" type="checkbox"/>	
Right	<input checked="" type="checkbox"/>		150.100.075
Left	<input checked="" type="checkbox"/>		150.100.076
Side Indicator Lamp	<input checked="" type="checkbox"/>		(yellow led)
Position Lamp	<input checked="" type="checkbox"/>		(white led)
Left-hand Drive	<input checked="" type="checkbox"/>		
Right-hand Drive	<input checked="" type="checkbox"/>		
E-Mark	<input checked="" type="checkbox"/>		II-E9-02.6657
Aspherical Mirror	<input checked="" type="checkbox"/>		(optional)
Colour	<input checked="" type="checkbox"/>		(optional)



Product ID: 150.100.067 – 150.100.068

Product Name: Neoplan

Features	Avlb.	Unavlb.	Info
Heater	<input checked="" type="checkbox"/>		(24v.)
Manual Adjustable		<input checked="" type="checkbox"/>	
Electric Adjustable	<input checked="" type="checkbox"/>		(24v.)
Mirror: Class II	<input checked="" type="checkbox"/>		
Mirror: Class IV		<input checked="" type="checkbox"/>	
Right	<input checked="" type="checkbox"/>		150.100.068
Left	<input checked="" type="checkbox"/>		150.100.067
Side Indicator Lamp		<input checked="" type="checkbox"/>	
Position Lamp		<input checked="" type="checkbox"/>	
Left-hand Drive	<input checked="" type="checkbox"/>		
Right-hand Drive	<input checked="" type="checkbox"/>		
E-Mark	<input checked="" type="checkbox"/>		II-E9-02.6658
Aspherical Mirror		<input checked="" type="checkbox"/>	
Colour	<input checked="" type="checkbox"/>		(optional)



Product ID: 150.100.054 - 150.100.057

Product Name: Neoplan

Features	Avlb.	Unavlb.	Info
Heater	<input checked="" type="checkbox"/>		(24v.)
Manual Adjustable	<input checked="" type="checkbox"/>		
Electric Adjustable		<input checked="" type="checkbox"/>	
Mirror: Class II	<input checked="" type="checkbox"/>		
Mirror: Class IV		<input checked="" type="checkbox"/>	
Right	<input checked="" type="checkbox"/>		150.100.054
Left	<input checked="" type="checkbox"/>		150.100.057
Side Indicator Lamp		<input checked="" type="checkbox"/>	
Position Lamp		<input checked="" type="checkbox"/>	
Left-hand Drive	<input checked="" type="checkbox"/>		
Right-hand Drive	<input checked="" type="checkbox"/>		
E-Mark	<input checked="" type="checkbox"/>		II-E9-02.6658
Aspherical Mirror	<input checked="" type="checkbox"/>		
Colour	<input checked="" type="checkbox"/>		(optional)



Product ID: 150.100.167 - 150.100.168

Product Name: Univera Side Mirror

Features	Avlb.	Unavlb.	Info
Heater	<input checked="" type="checkbox"/>		(24v.)
Manual Adjustable		<input checked="" type="checkbox"/>	
Electric Adjustable	<input checked="" type="checkbox"/>		(24v.)
Mirror: Class II	<input checked="" type="checkbox"/>		
Mirror: Class IV		<input checked="" type="checkbox"/>	
Right	<input checked="" type="checkbox"/>		150.100.167
Left	<input checked="" type="checkbox"/>		150.100.168
Side Indicator Lamp	<input checked="" type="checkbox"/>		(yellow led)
Position Lamp	<input checked="" type="checkbox"/>		(white led)
Left-hand Drive	<input checked="" type="checkbox"/>		
Right-hand Drive	<input checked="" type="checkbox"/>		
E-Mark	<input checked="" type="checkbox"/>		II-E9-02.6657
Aspherical Mirror		<input checked="" type="checkbox"/>	
Colour	<input checked="" type="checkbox"/>		(optional)



Product ID: 150.100.163 – 150.100.164

Product Name: O403 Side Mirror

Features	Avlb.	Unavlb.	Info
Heater	<input checked="" type="checkbox"/>		(24v.)
Manual Adjustable		<input checked="" type="checkbox"/>	
Electric Adjustable	<input checked="" type="checkbox"/>		(24v.)
Mirror: Class II	<input checked="" type="checkbox"/>		
Mirror: Class IV		<input checked="" type="checkbox"/>	
Right	<input checked="" type="checkbox"/>		150.100.163
Left	<input checked="" type="checkbox"/>		150.100.164
Side Indicator Lamp		<input checked="" type="checkbox"/>	
Position Lamp		<input checked="" type="checkbox"/>	
Left-hand Drive	<input checked="" type="checkbox"/>		
Right-hand Drive	<input checked="" type="checkbox"/>		
E-Mark	<input checked="" type="checkbox"/>		II-E9-03.6921
Aspherical Mirror		<input checked="" type="checkbox"/>	
Colour	<input checked="" type="checkbox"/>		(optional)



Product ID: 150.100.165 – 150.100.166

Product Name: Neoplan Side Mirror

Features	Avlb.	Unavlb.	Info
Heater	<input checked="" type="checkbox"/>		(24v.)
Manual Adjustable		<input checked="" type="checkbox"/>	
Electric Adjustable	<input checked="" type="checkbox"/>		(24v.)
Mirror: Class II	<input checked="" type="checkbox"/>		
Mirror: Class IV		<input checked="" type="checkbox"/>	
Right	<input checked="" type="checkbox"/>		150.100.165
Left	<input checked="" type="checkbox"/>		150.100.166
Side Indicator Lamp		<input checked="" type="checkbox"/>	
Position Lamp		<input checked="" type="checkbox"/>	
Left-hand Drive	<input checked="" type="checkbox"/>		
Right-hand Drive	<input checked="" type="checkbox"/>		
E-Mark	<input checked="" type="checkbox"/>		II-E9-02.6658
Aspherical Mirror		<input checked="" type="checkbox"/>	
Colour	<input checked="" type="checkbox"/>		(optional)



Product ID: 150.100.037 – 150.100.038

Product Name: Sultan

Features	Avlb.	Unavlb.	Info
Heater	<input checked="" type="checkbox"/>		(24v.)
Manual Adjustable	<input checked="" type="checkbox"/>		
Electric Adjustable		<input checked="" type="checkbox"/>	
Mirror: Class II	<input checked="" type="checkbox"/>		
Mirror: Class IV		<input checked="" type="checkbox"/>	
Right	<input checked="" type="checkbox"/>		150.100.037
Left	<input checked="" type="checkbox"/>		150.100.038
Side Indicator Lamp		<input checked="" type="checkbox"/>	
Position Lamp		<input checked="" type="checkbox"/>	
Left-hand Drive	<input checked="" type="checkbox"/>		
Right-hand Drive	<input checked="" type="checkbox"/>		
E-Mark	<input checked="" type="checkbox"/>		II-E9-02.6658
Aspherical Mirror		<input checked="" type="checkbox"/>	
Colour	<input checked="" type="checkbox"/>		(optional)



Product ID: 150.100.169 – 150.100.170

Product Name: M2010

Features	Avlb.	Unavlb.	Info
Heater	<input checked="" type="checkbox"/>		(24v.)
Manual Adjustable	<input checked="" type="checkbox"/>		
Electric Adjustable		<input checked="" type="checkbox"/>	
Mirror: Class II	<input checked="" type="checkbox"/>		
Mirror: Class IV		<input checked="" type="checkbox"/>	
Right	<input checked="" type="checkbox"/>		150.100.169
Left	<input checked="" type="checkbox"/>		150.100.170
Side Indicator Lamp		<input checked="" type="checkbox"/>	
Position Lamp		<input checked="" type="checkbox"/>	
Left-hand Drive	<input checked="" type="checkbox"/>		
Right-hand Drive	<input checked="" type="checkbox"/>		
E-Mark	<input checked="" type="checkbox"/>		II-E9-03.6921
Aspherical Mirror		<input checked="" type="checkbox"/>	
Colour	<input checked="" type="checkbox"/>		(optional)



Product ID: 150.100.052 – 150.100.001

Product Name: Iveco Eurobus

Features	Avlb.	Unavlb.	Info
Heater	<input checked="" type="checkbox"/>		(24v.)
Manual Adjustable	<input checked="" type="checkbox"/>		
Electric Adjustable		<input checked="" type="checkbox"/>	
Mirror: Class II	<input checked="" type="checkbox"/>		
Mirror: Class IV		<input checked="" type="checkbox"/>	
Right	<input checked="" type="checkbox"/>		150.100.052
Left	<input checked="" type="checkbox"/>		150.100.001
Side Indicator Lamp		<input checked="" type="checkbox"/>	
Position Lamp		<input checked="" type="checkbox"/>	
Left-hand Drive	<input checked="" type="checkbox"/>		
Right-hand Drive	<input checked="" type="checkbox"/>		
E-Mark	<input checked="" type="checkbox"/>		II-E9-02.6658
Aspherical Mirror		<input checked="" type="checkbox"/>	
Colour	<input checked="" type="checkbox"/>		(optional)



Product ID: 150.100.039 – 150.100.040

Product Name: Isuzu Roybus

Features	Avlb.	Unavlb.	Info
Heater	<input checked="" type="checkbox"/>		(24v.)
Manual Adjustable		<input checked="" type="checkbox"/>	
Electric Adjustable	<input checked="" type="checkbox"/>		(24v.)
Mirror: Class II	<input checked="" type="checkbox"/>		
Mirror: Class IV		<input checked="" type="checkbox"/>	
Right	<input checked="" type="checkbox"/>		150.100.040
Left	<input checked="" type="checkbox"/>		150.100.039
Side Indicator Lamp		<input checked="" type="checkbox"/>	
Position Lamp		<input checked="" type="checkbox"/>	
Left-hand Drive	<input checked="" type="checkbox"/>		
Right-hand Drive	<input checked="" type="checkbox"/>		
E-Mark	<input checked="" type="checkbox"/>		II-E9-03.6921
Aspherical Mirror		<input checked="" type="checkbox"/>	
Colour	<input checked="" type="checkbox"/>		(optional)



Product ID: 150.100.041 – 150.100.042

Product Name: Isuzu Roybus

Features	Avlb.	Unavlb.	Info
Heater	<input checked="" type="checkbox"/>		(24v.)
Manual Adjustable		<input checked="" type="checkbox"/>	
Electric Adjustable	<input checked="" type="checkbox"/>		
Mirror: Class II	<input checked="" type="checkbox"/>		
Mirror: Class IV		<input checked="" type="checkbox"/>	
Right	<input checked="" type="checkbox"/>		150.100.042
Left	<input checked="" type="checkbox"/>		150.100.041
Side Indicator Lamp		<input checked="" type="checkbox"/>	
Position Lamp		<input checked="" type="checkbox"/>	
Left-hand Drive	<input checked="" type="checkbox"/>		
Right-hand Drive	<input checked="" type="checkbox"/>		
E-Mark	<input checked="" type="checkbox"/>		II-E9-03.6921
Aspherical Mirror		<input checked="" type="checkbox"/>	
Colour	<input checked="" type="checkbox"/>		(optional)



Product ID: 150.100.043 – 150.100.044

Product Name: Isuzu Turkuaz

Features	Avlb.	Unavlb.	Info
Heater	<input checked="" type="checkbox"/>		(24v.)
Manual Adjustable	<input checked="" type="checkbox"/>		
Electric Adjustable		<input checked="" type="checkbox"/>	
Mirror: Class II	<input checked="" type="checkbox"/>		
Mirror: Class IV		<input checked="" type="checkbox"/>	
Right	<input checked="" type="checkbox"/>		150.100.044
Left	<input checked="" type="checkbox"/>		150.100.043
Side Indicator Lamp		<input checked="" type="checkbox"/>	
Position Lamp		<input checked="" type="checkbox"/>	
Left-hand Drive	<input checked="" type="checkbox"/>		
Right-hand Drive	<input checked="" type="checkbox"/>		
E-Mark	<input checked="" type="checkbox"/>		II-E9-02.6658
Aspherical Mirror		<input checked="" type="checkbox"/>	
Colour	<input checked="" type="checkbox"/>		(optional)



Product ID: 150.100.001 – 150.100.002

Product Name: Prensés

Features	Avlb.	Unavlb.	Info
Heater	<input checked="" type="checkbox"/>		(24v.)
Manual Adjustable	<input checked="" type="checkbox"/>		
Electric Adjustable		<input checked="" type="checkbox"/>	
Mirror: Class II	<input checked="" type="checkbox"/>		
Mirror: Class IV		<input checked="" type="checkbox"/>	
Right	<input checked="" type="checkbox"/>		150.100.002
Left	<input checked="" type="checkbox"/>		150.100.001
Side Indicator Lamp		<input checked="" type="checkbox"/>	
Position Lamp		<input checked="" type="checkbox"/>	
Left-hand Drive	<input checked="" type="checkbox"/>		
Right-hand Drive	<input checked="" type="checkbox"/>		
E-Mark	<input checked="" type="checkbox"/>		II-E9-02.6658
Aspherical Mirror		<input checked="" type="checkbox"/>	
Colour	<input checked="" type="checkbox"/>		(optional)



Product ID: 150.100.003 – 150.100.004

Product Name: Prensés Original

Features	Avlb.	Unavlb.	Info
Heater	<input checked="" type="checkbox"/>		(24v.)
Manual Adjustable		<input checked="" type="checkbox"/>	
Electric Adjustable	<input checked="" type="checkbox"/>		(24v.)
Mirror: Class II	<input checked="" type="checkbox"/>		
Mirror: Class IV		<input checked="" type="checkbox"/>	
Right	<input checked="" type="checkbox"/>		150.100.004
Left	<input checked="" type="checkbox"/>		150.100.003
Side Indicator Lamp		<input checked="" type="checkbox"/>	
Position Lamp		<input checked="" type="checkbox"/>	
Left-hand Drive	<input checked="" type="checkbox"/>		
Right-hand Drive	<input checked="" type="checkbox"/>		
E-Mark	<input checked="" type="checkbox"/>		II-E9-02.6658
Aspherical Mirror		<input checked="" type="checkbox"/>	
Colour	<input checked="" type="checkbox"/>		(optional)



Product ID: 150.100.007 – 150.100.008

Product Name: Presses Original

Features	Avlb.	Unavlb.	Info
Heater	<input checked="" type="checkbox"/>		(24v.)
Manual Adjustable		<input checked="" type="checkbox"/>	
Electric Adjustable	<input checked="" type="checkbox"/>		(24v.)
Mirror: Class II	<input checked="" type="checkbox"/>		
Mirror: Class IV		<input checked="" type="checkbox"/>	
Right	<input checked="" type="checkbox"/>		150.100.007
Left	<input checked="" type="checkbox"/>		150.100.008
Side Indicator Lamp		<input checked="" type="checkbox"/>	
Position Lamp		<input checked="" type="checkbox"/>	
Left-hand Drive	<input checked="" type="checkbox"/>		
Right-hand Drive	<input checked="" type="checkbox"/>		
E-Mark	<input checked="" type="checkbox"/>		II-E9-02.6658
Aspherical Mirror		<input checked="" type="checkbox"/>	
Colour	<input checked="" type="checkbox"/>		(optional)



Product ID: 150.100.009 – 150.100.010

Product Name: Safir

Features	Avlb.	Unavlb.	Info
Heater	<input checked="" type="checkbox"/>		(24v.)
Manual Adjustable	<input checked="" type="checkbox"/>		
Electric Adjustable		<input checked="" type="checkbox"/>	
Mirror: Class II	<input checked="" type="checkbox"/>		
Mirror: Class IV	<input checked="" type="checkbox"/>		
Right	<input checked="" type="checkbox"/>		150.100.010
Left	<input checked="" type="checkbox"/>		150.100.009
Side Indicator Lamp		<input checked="" type="checkbox"/>	
Position Lamp		<input checked="" type="checkbox"/>	
Left-hand Drive	<input checked="" type="checkbox"/>		
Right-hand Drive	<input checked="" type="checkbox"/>		
E-Mark		<input checked="" type="checkbox"/>	
Aspherical Mirror		<input checked="" type="checkbox"/>	
Colour	<input checked="" type="checkbox"/>		(optional)



Product ID: 150.100.011 – 150.100.012

Product Name: Safir Original

Features	Avlb.	Unavlb.	Info
Heater	<input checked="" type="checkbox"/>		(24v.)
Manual Adjustable	<input checked="" type="checkbox"/>		
Electric Adjustable		<input checked="" type="checkbox"/>	
Mirror: Class II	<input checked="" type="checkbox"/>		
Mirror: Class IV	<input checked="" type="checkbox"/>		
Right	<input checked="" type="checkbox"/>		150.100.011
Left	<input checked="" type="checkbox"/>		150.100.012
Side Indicator Lamp		<input checked="" type="checkbox"/>	
Position Lamp		<input checked="" type="checkbox"/>	
Left-hand Drive	<input checked="" type="checkbox"/>		
Right-hand Drive	<input checked="" type="checkbox"/>		
E-Mark		<input checked="" type="checkbox"/>	
Aspherical Mirror		<input checked="" type="checkbox"/>	
Colour	<input checked="" type="checkbox"/>		(optional)



Product ID: 150.100.045 – 150.100.046

Product Name: Prestij

Features	Avlb.	Unavlb.	Info
Heater	<input checked="" type="checkbox"/>		(24v.)
Manual Adjustable	<input checked="" type="checkbox"/>		
Electric Adjustable		<input checked="" type="checkbox"/>	
Mirror: Class II	<input checked="" type="checkbox"/>		
Mirror: Class IV		<input checked="" type="checkbox"/>	
Right	<input checked="" type="checkbox"/>		150.100.046
Left	<input checked="" type="checkbox"/>		150.100.045
Side Indicator Lamp		<input checked="" type="checkbox"/>	
Position Lamp		<input checked="" type="checkbox"/>	
Left-hand Drive	<input checked="" type="checkbox"/>		
Right-hand Drive	<input checked="" type="checkbox"/>		
E-Mark	<input checked="" type="checkbox"/>		II-E9-02.6658
Aspherical Mirror		<input checked="" type="checkbox"/>	
Colour	<input checked="" type="checkbox"/>		(optional)



Product ID: 150.100.047 – 150.100.048

Product Name: Prestij Original

Features	Avlb.	Unavlb.	Info
Heater	<input checked="" type="checkbox"/>		(24v.)
Manual Adjustable		<input checked="" type="checkbox"/>	
Electric Adjustable	<input checked="" type="checkbox"/>		(24v.)
Mirror: Class II	<input checked="" type="checkbox"/>		
Mirror: Class IV		<input checked="" type="checkbox"/>	
Right	<input checked="" type="checkbox"/>		150.100.048
Left	<input checked="" type="checkbox"/>		150.100.047
Side Indicator Lamp		<input checked="" type="checkbox"/>	
Position Lamp		<input checked="" type="checkbox"/>	
Left-hand Drive	<input checked="" type="checkbox"/>		
Right-hand Drive	<input checked="" type="checkbox"/>		
E-Mark	<input checked="" type="checkbox"/>		II-E9-02.6658
Aspherical Mirror		<input checked="" type="checkbox"/>	
Colour	<input checked="" type="checkbox"/>		(optional)



Product ID: 150.100.049 – 150.100.050

Product Name: Prestij Original

Features	Avlb.	Unavlb.	Info
Heater	<input checked="" type="checkbox"/>		(24v.)
Manual Adjustable		<input checked="" type="checkbox"/>	
Electric Adjustable	<input checked="" type="checkbox"/>		(24v.)
Mirror: Class II	<input checked="" type="checkbox"/>		
Mirror: Class IV		<input checked="" type="checkbox"/>	
Right	<input checked="" type="checkbox"/>		150.100.049
Left	<input checked="" type="checkbox"/>		150.100.050
Side Indicator Lamp		<input checked="" type="checkbox"/>	
Position Lamp		<input checked="" type="checkbox"/>	
Left-hand Drive	<input checked="" type="checkbox"/>		
Right-hand Drive	<input checked="" type="checkbox"/>		
E-Mark	<input checked="" type="checkbox"/>		II-E9-02.6658
Aspherical Mirror		<input checked="" type="checkbox"/>	
Colour	<input checked="" type="checkbox"/>		(optional)



● Product ID: 150.100.118 - 150.100.119

● *Product Name: O345 Conecto*



● Product ID: 150.100.177 - 150.100.178

● *Product Name: Temsa Avenue*



● Product ID: 150.100.172 - 150.100.173

● *Product Name: Otokar Doruk 190 LE*



● Product ID: 150.100.094 - 150.100.181

● *Product Name: Otokar Doruk 220 LE*



● Product ID: 150.130.008 - 150.130.009

● *Product Name: O345 Conecto*



● Product ID: 150.130.019 - 150.130.020

● *Product Name: Otokar*



● Product ID: 150.130.130 - 150.130.131

● *Product Name: Doruk 190 LE*

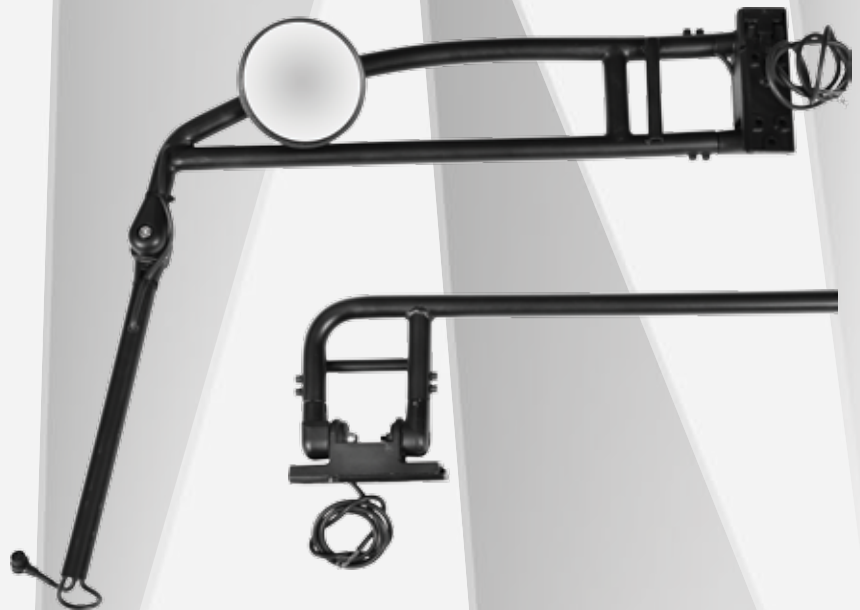

● Product ID: 150.130.094 - 150.130.095

● *Product Name: Temsa Avenue*



● Product ID: 150.130.010 - 150.130.011

● *Product Name: Iveco M50*



● Product ID: 150.130.017 - 150.130.018

● *Product Name: Iveco Eurobus*



● Product ID: 150.130.029 - 150.130.030

● *Product Name: V-6*



● Product ID: 150.130.031 - 150.130.032

● *Product Name: V-8*



● Product ID: 150.130.037 - 150.130.045
● *Product Name: BMC*



● Product ID: 150.130.022 - 150.130.023
● *Product Name: Champion*

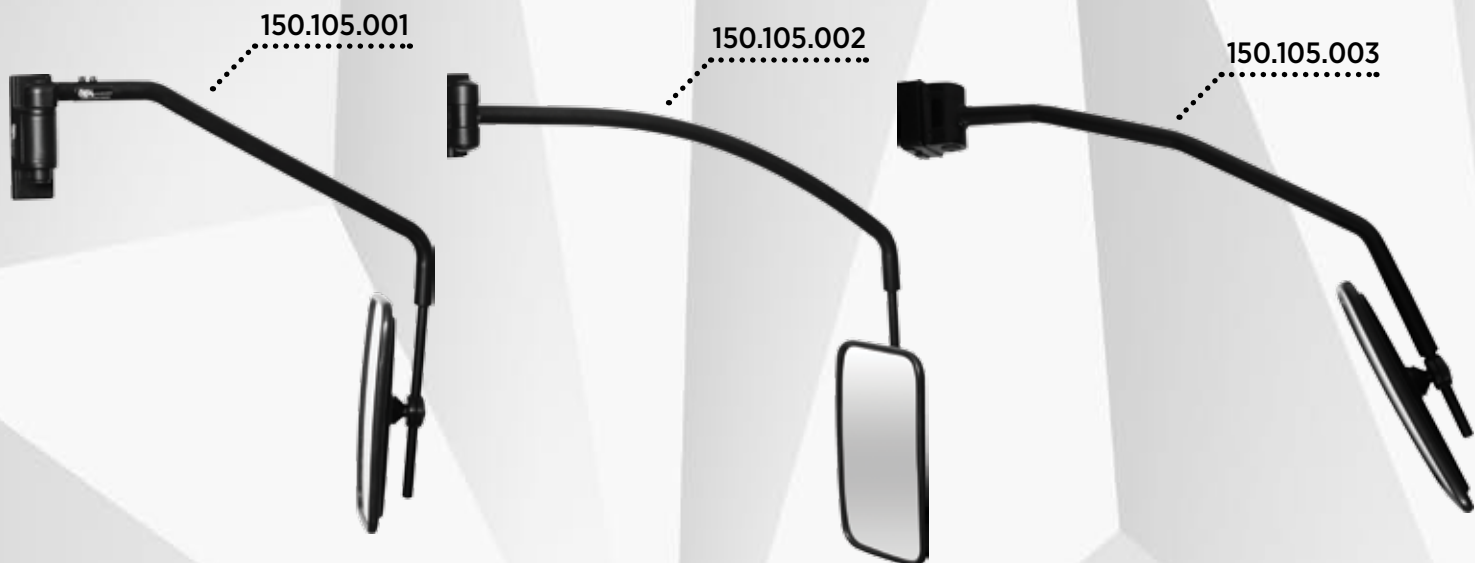

● Product ID: 150.105.001 - 150.105.002 - 150.105.003
● *Product Name: Universal Emergency Mirror*



- **Product ID:** Left
- 150.130.096 : O403 Manual
- 150.130.097 : O403 Electric (24V)
- 150.130.104 : Otokar Manual
- 150.130.105 : Otokar Electric (24V)

- **Product ID:** Left
- 150.130.099 : O403 Manual
- 150.130.101 : O403 Electric (24V)
- 150.130.109 : Man Manual
- 150.130.111 : Man Electric (24V)

- **Product ID:** Right
- 150.130.098 : O403 Manual
- 150.130.100 : O403 Electric (24V)
- 150.130.106 : Otokar Manual
- 150.130.107 : Otokar Electric (24V)
- 150.130.108 : Man Manual
- 150.130.110 : Man Electric (24V)

* Included



- Product ID: Left
- 150.130.102 : Otokar Manual
- 150.130.103 : Otokar Electric (24V)



- Product ID: Right
- 150.130.112 : Provera Manual
- 150.130.114 : Provera Electric (24V)



- Product ID: Left
- 150.130.113 : Provera Manual
- 150.130.115 : Provera Electric (24V)



Product ID: 150.110.001

Product Name: *Prenses Manual*



Product ID: 150.110.002

Product Name: *Prenses Electric (24V)*



Product ID: 150.110.003

Product Name: *O345 , Heated*



Product ID: 150.110.064

Product Name: *Safir Manual Heated*



● Product ID: 150.110.004 Left
● *Product Name: O403 Electric (24V)*



● Product ID: 150.110.005 Right
● *Product Name: O403 Electric (24V)*



● Product ID: 150.110.006 Left
● *Product Name: O403 Manual*



● Product ID: 150.110.007 Right
● *Product Name: O403 Manual*



● Product ID: 150.110.012

● Product Name: V-6



● Product ID: 150.110.013

● Product Name: V-6 Heated



● Product ID: 150.110.018

● Product Name: V-8



● Product ID: 150.110.019

● Product Name: V-8 Heated



● **Product ID: 150.110.073**
● **Product Name: Diamond Electric (24V)**



● **Product ID: 150.110.074**
● **Product Name: Univera Electric (24V)**



● **Product ID: 150.111.001**
● **Product Name: M2000**



● **Product ID: 150.111.003**
● **Product Name: Man**



● **Product ID: 150.111.004**

● **Product Name: Front Buffer Mirror**



● **Product ID: 150.111.005**

● **Product Name: Front Buffer Mirror**



● **Product ID: 150.111.007**

● **Product Name: Front Buffer Mirror**



● **Product ID: 150.111.010**

● **Product Name: Atego**



● **Product ID: 150.111.008**
● Product Name: Door Mirror



● **Product ID: 150.111.012**
● Product Name: Actros



● **Product ID: 150.111.014**
● Product Name: Universal Driver Mirror



● **Product ID: 150.111.016** ø28cm
● Product Name: Convex Cross Mirror



● Product ID: 150.111.017 ø26cm
● *Product Name: Convex Cross Mirror*



● Product ID: 150.111.018 ø50cm
● *Product Name: Convex Cross Mirror*

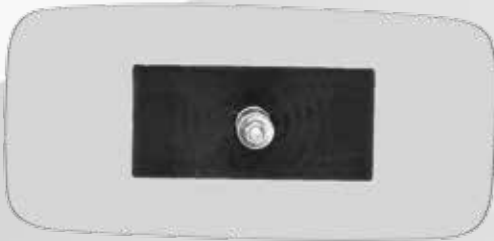

● Product ID: 150.112.001 36*17.5cm
● *Product Name: Millenium*



● Product ID: 150.112.002 30*15cm
● *Product Name: Millenium*



● Product ID: 150.112.003 30*12.5cm
● *Product Name: Millenium*



● Product ID: 150.112.004
● *Product Name: O304*



● Product ID: 150.112.005
● *Product Name: M50*



● Product ID: 150.112.006
● *Product Name: SPRINTER/DUCATO/VOLT
JUMPER/BOXER/J9/T16/DAILY*



● **Product ID: 150.112.007**

● **Product Name: M50 With Arm**



● **Product ID: 150.112.008**

● **Product Name: Universal**



● **Product ID: 150.112.009** **ø20.5cm**

● **Product Name: In-Corner Mirror**



● **Product ID: 150.112.010** **ø28.5cm**

● **Product Name: In-Corner Mirror**



● **Product ID: 150.112.012**

● **Product Name: Man**



● **Product ID: 150.112.013** 27*15cm

● **Product Name: Nazar**



● **Product ID: 150.112.014** 30*9.5cm

● **Product Name: Voltran**



● **Product ID: 150.112.015** 30*9.5cm

● **Product Name: Voltran**



● **Product ID: 150.112.016** 28*9cm
● *Product Name: Voltran*



● **Product ID: 150.112.017** 25*9cm
● *Product Name: Voltran*



● **Product ID: 150.113.010**
● *Product Name: Isuzu NPR*



● **Product ID: 150.113.011**
● *Product Name: Isuzu NPR Old Model*



● Product ID: 150.113.012
● Product Name: *Isuzu NQR*



● Product ID: 150.113.013
● Product Name: *Isuzu*



● Product ID: 150.113.019
● Product Name: *Mitsubishi Fuso*



● Product ID: 150.113.020
● Product Name: *Mitsubishi Canter*



Product ID: 150.113.021

Product Name: Canter 449



Product ID: 150.113.028

Product Name: Canter 659



Product ID: 150.113.029

Product Name: Iveco 50 NC

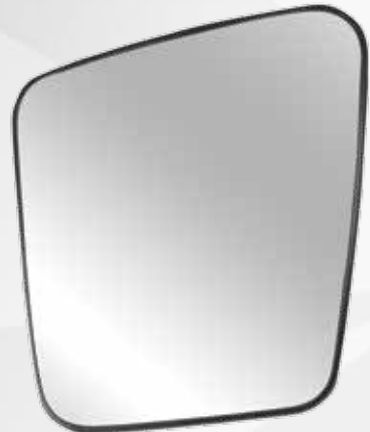

Product ID: 150.115.001

Product Name: O403



● Product ID: 150.115.002
● Product Name: O403



● Product ID: 150.115.003
● Product Name: O403



● Product ID: 150.115.036
● Product Name: Diamond



● Product ID: 150.115.038
● Product Name: Diamond



Product ID: 150.115.044

Product Name: Travego



Product ID: 150.115.045

Product Name: Travego



Product ID: 150.120.001

Product Name: Diamond

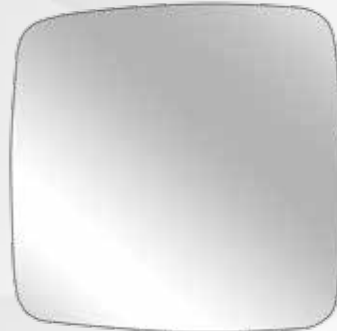

Product ID: 150.120.002

Product Name: Diamond

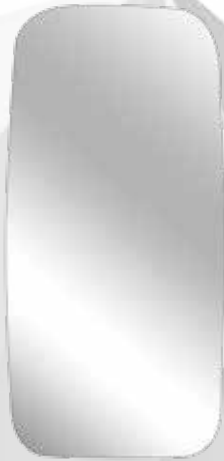

● Product ID: 150.120.006
●

● *Product Name: V-6*



● Product ID: 150.120.007
●

● *Product Name: V-8*



● Product ID: 150.120.009
●

● *Product Name: Prensas*



● Product ID: 150.120.012
●

● *Product Name: O403*

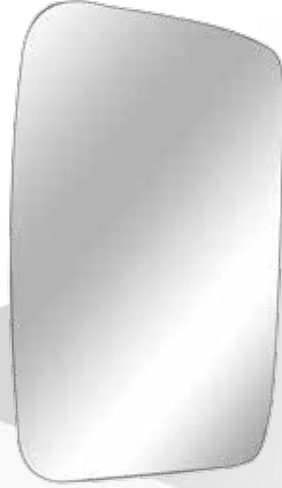
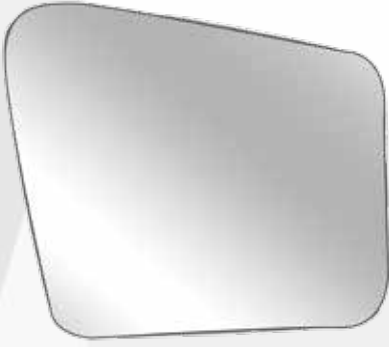

● **Product ID: 150.120.013**

● **Product Name: O403**

● **Product ID: 150.120.014**

● **Product Name: O403**

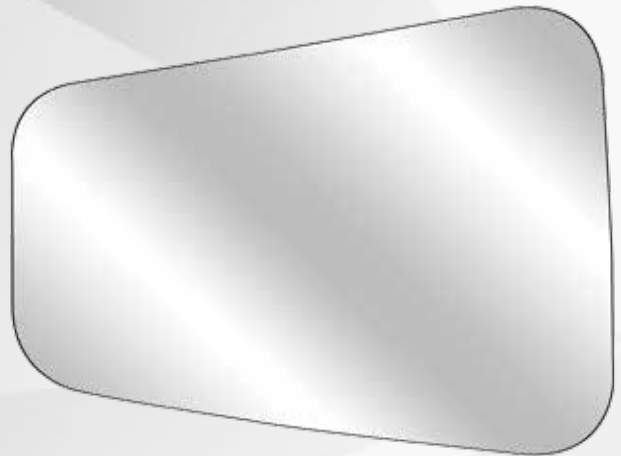
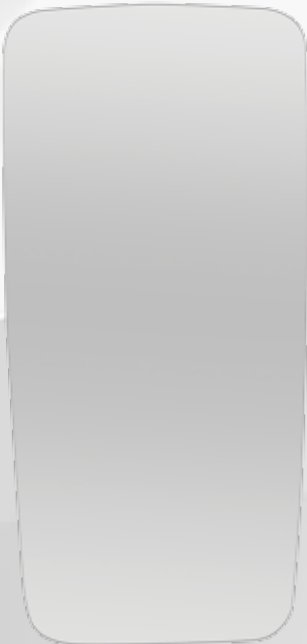

● **Product ID: 150.120.187**

● **Product Name: Travego**

● **Product ID: 150.120.199**

● **Product Name: Travego**



● Product ID: 150.130.016
● Product Name: M50



● Product ID: 150.130.021
● Product Name: Sultan



33cm
50cm
69cm

● Product ID: 150.130.055
● Product Name: Universal



● Product ID: 150.130.038
● Product Name: In-Corner



● **Product ID: 150.169.023**

● **Product Name: Int. Mirror Holder**



● **Product ID: 150.169.008**

● **Product Name: Setting Switch**



● **Product ID: 150.155.001**

● **Product Name: Bracket**



● **Product ID: 150.156.001**

● **Product Name: O403 Bellows**



● Product ID: 150.159.008
● *Product Name: Plastic Articulation*



● Product ID: 150.169.010 - 150.169.039
● *Product Name: Adaptor*



● Product ID: 150.169.009 - 150.169.038
● *Product Name: Adaptor*



● Product ID: 150.158.001
● *Product Name: O403 Bracket*



● **Product ID: 150.158.003**

● **Product Name: Prensas Bracket**



● **Product ID: 150.158.004**

● **Product Name: M50 Bracket**



● **Product ID: 150.158.007**

● **Product Name: ÖFA R Bracket**



● **Product ID: 150.158.008**

● **Product Name: ÖFA L Bracket**



● Product ID: 150.158.014
● *Product Name: Diamond*



● Product ID: 150.160.005
● *Product Name: O403 Mounting Plate*



● Product ID: 150.160.006
● *Product Name: Presses Mounting Plate*



● Product ID: 150.160.012
● *Product Name: Diamond Mounting Plate*

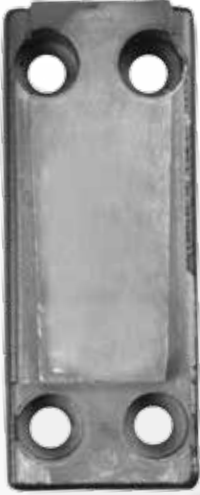

● **Product ID: 150.160.001**

● **Product Name: M50 Mounting Plate**

● **Product ID: 150.160.002**

● **Product Name: ÖFA Mounting Plate**



Notlar / Notes

A series of horizontal dotted lines for writing notes.



**OTO AYNA SAN. VE TİC. LTD. ŞTİ.
AUTO MIRROR IND. TRADE Co. LTD.**

Contact Information

Address : Veysel Karani Mah. 17. Ay Sk. No: 40

Osmangazi / BURSA TR-16250

Telephone 1 : +90 224 215 56 54

Telephone 2 : +90 224 215 56 85

Fax : +90 224 215 56 84

E-mail : ofa@ofa.com.tr



www.ofa.com.tr